

MulliXKing installation

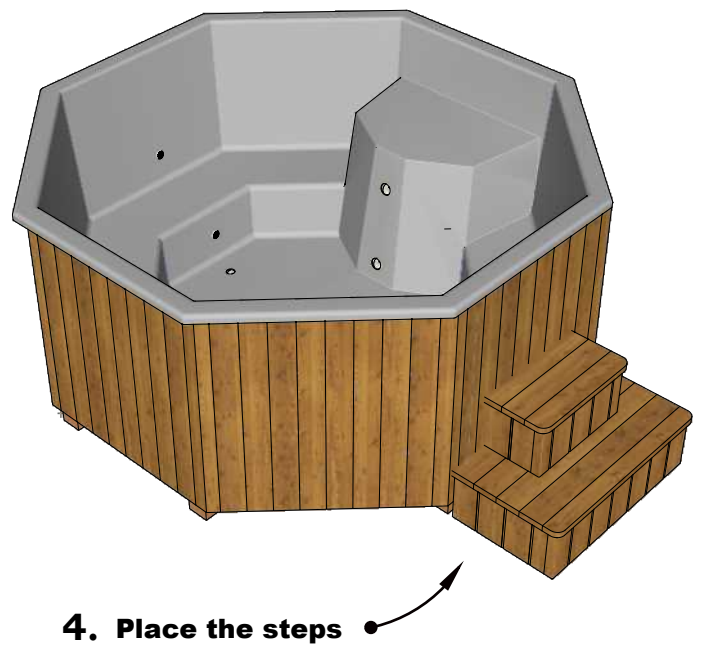

MulliXKing installation

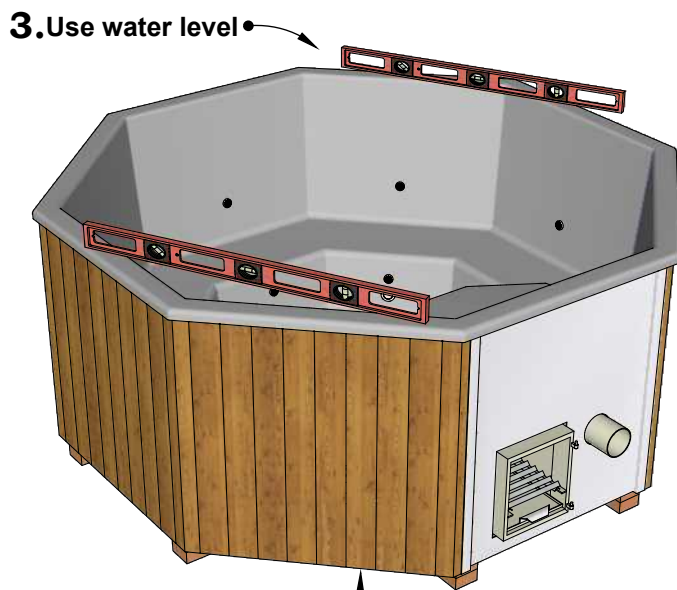
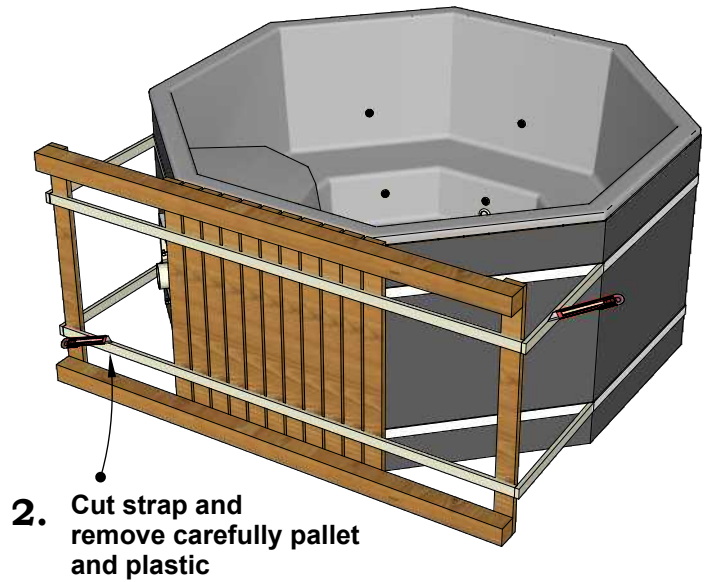
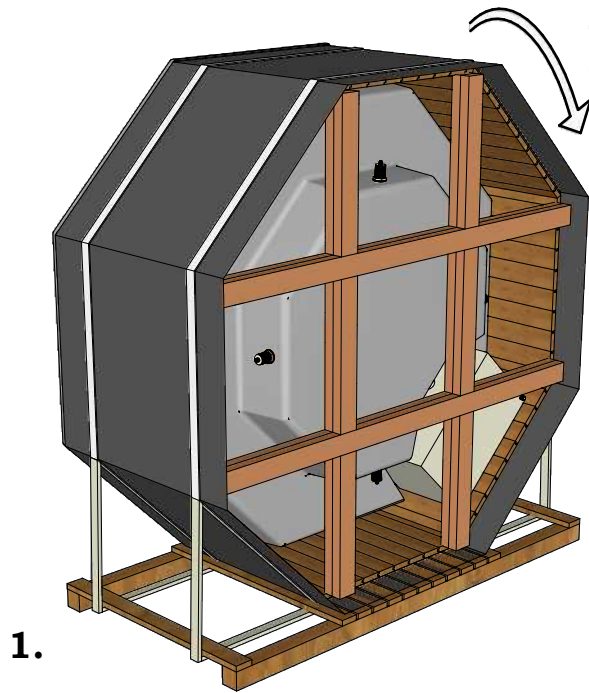
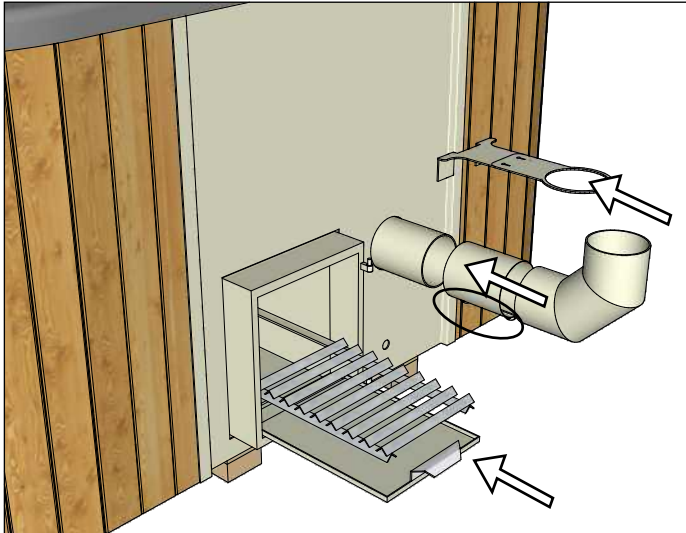

5.

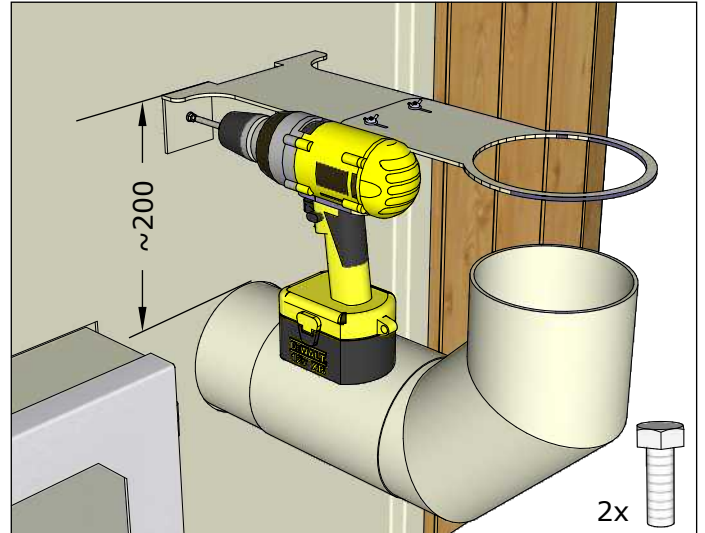

6.

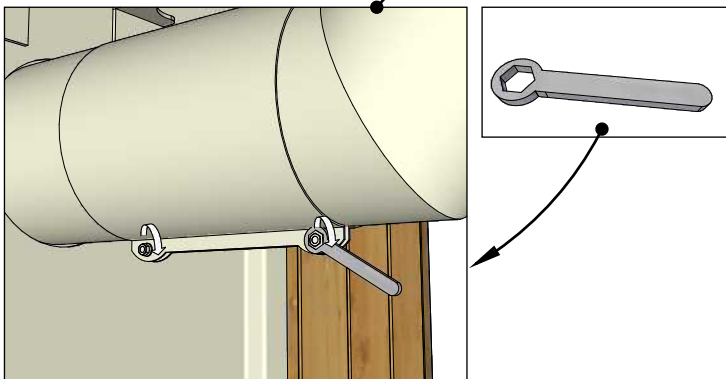

7.

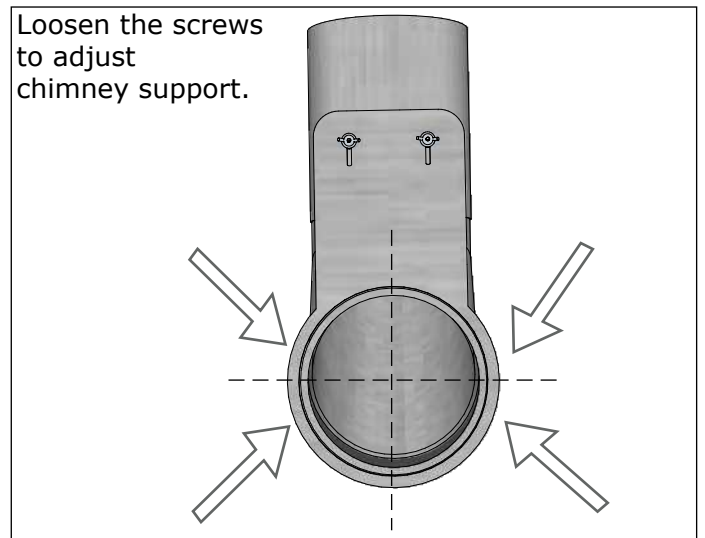

Loosen the screws to adjust chimney support.

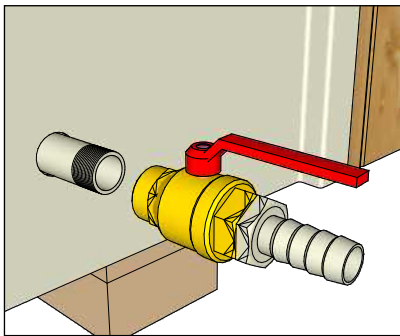

8.

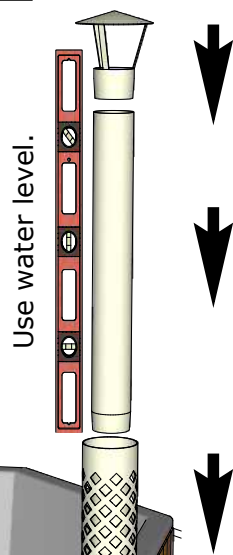

Use water level.

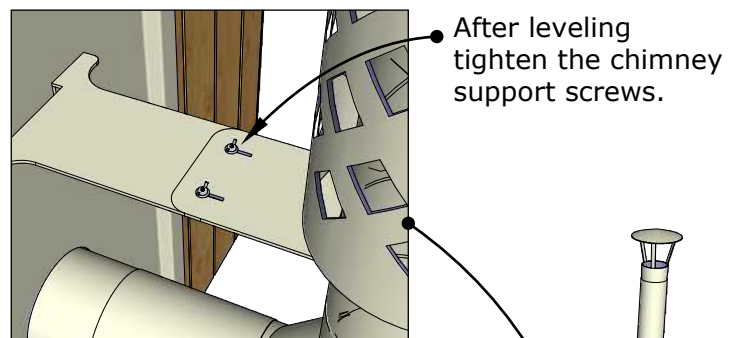

9.

After leveling tighten the chimney support screws.

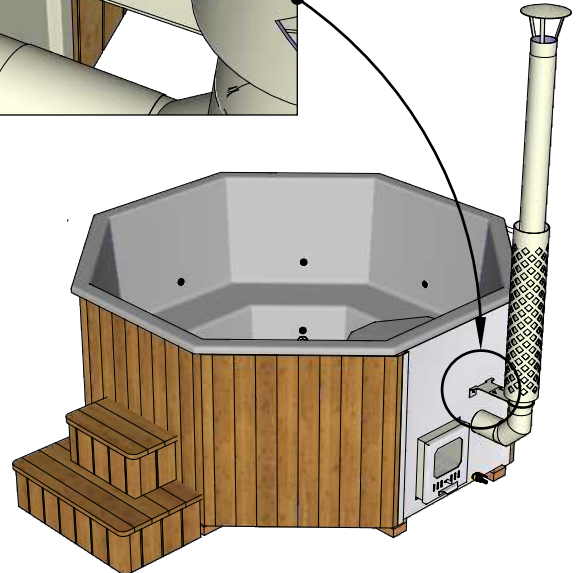
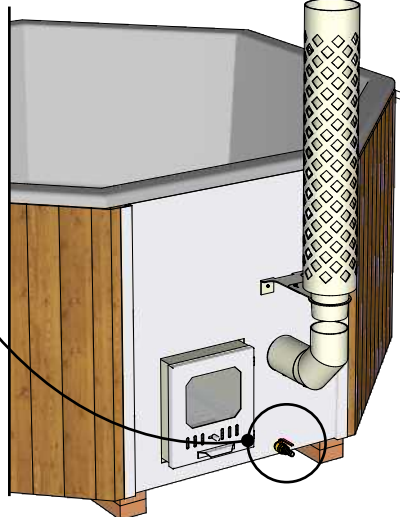

MulliXKing installation

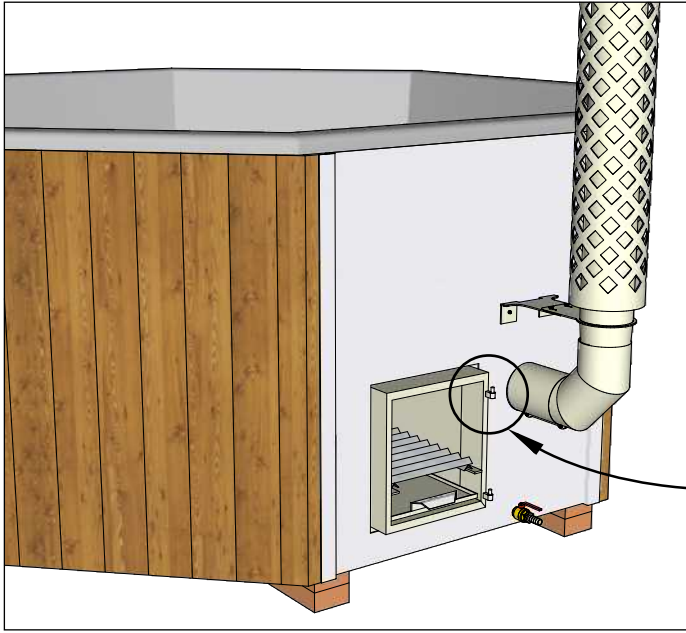

10.

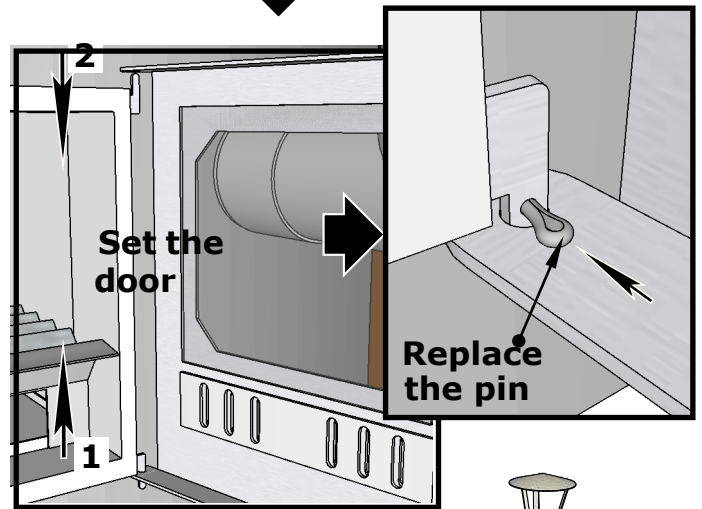
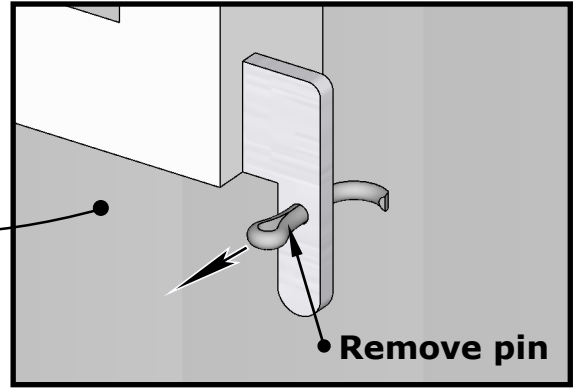

Maximum level of water
from rim 150 mm

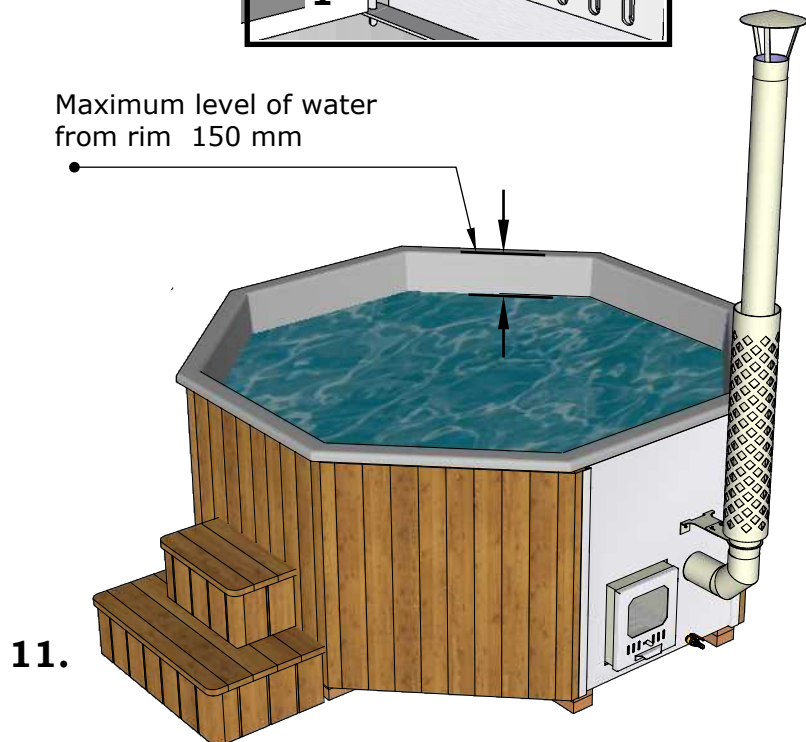

11.